

Installation Guide

SAFETY INSTRUCTIONS

To guarantee the safety of installers, we recommend wearing gloves, safety shoes and a hard hat.



GLUES AND TOOLS

Glues:

- CorsoShield Wall® products are applied to walls and surfaces using specific adhesive: CORSOGLUE®. The reference of the required glue depends on the wall/surface.
- Average glue consumption: 250g / m²

Surface type		Glue
Open	Coarse plaster BA13 Painted backgrounds (acrylic matt paints) MDF	CORSOGLUE®. E2301/13EX (drying time 15 to 20 min)
Closed	Painted backgrounds (alkyd and glycerophthalic paints, CorsoShield®) Melamine faced Particle board	CORSOGLUE®. E2928/2EX (drying time 10 to 15 mins.)



Outils:

Paint tray (with grill)



Paint brush



Roller (12mm for E2301/13EX
Glue ; 9mm for E2928/2EX
glue)



Microfiber cloth

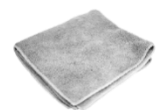

Mesuring tape



Cutter (blade 0.25
mm)



Smoothing tool



INSTALLATION

The cans of glue contain 10kg. The glue must be transferred to the tray fitted with a grill in order to remove excess glue from the roller during application.

Preparation of the lengths: Position the roll vertically. With the help of a second person, unroll the film to the desired length (place the meter along the unrolled length), then add 5 cm more than the height of the wall.

Using a cutter, cut the strip, from bottom to top. Taking care not to make a cut on the surface

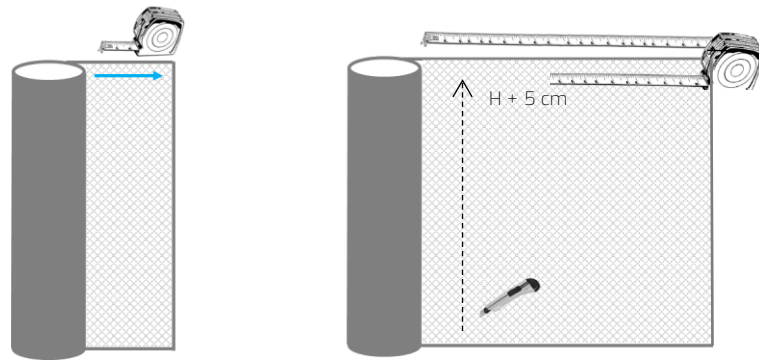

Roll up the length: ensure the glass mat is on the outside. Roll up the length.

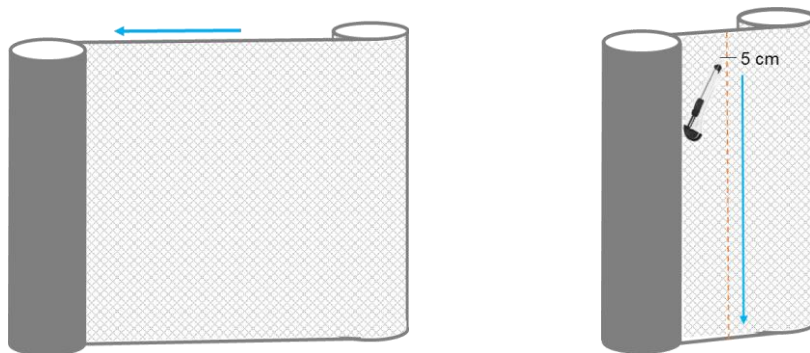

1st step: Application of CorsoShield Extra 20 cm:

- The Extra 20cm must be applied around the edges of the wall which is shielded:
 - Baseboards / Duct
 - Doors and door frames
 - Conduits
- For CorsoShield Extra 20 cm on **baseboards / duct**, use a brush to apply Corso Glue to the entire baseboard (except electrical outlet). Then apply the Extra 20 cm evenly: 10 cm on the top and 10 cm on the bottom of the baseboard.

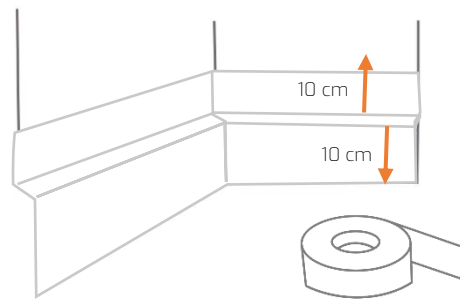
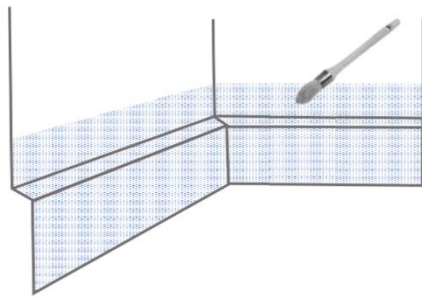

- To apply the Extra 20 cm to a **door** and door **frame**, use a brush to apply CorsoGlue to the entire door frame. To do this, open the door to correctly apply the glue inside and outside of the frame.
- Then apply the Extra 20 cm evenly: 10 cm inside and 10 cm outside the door frame.

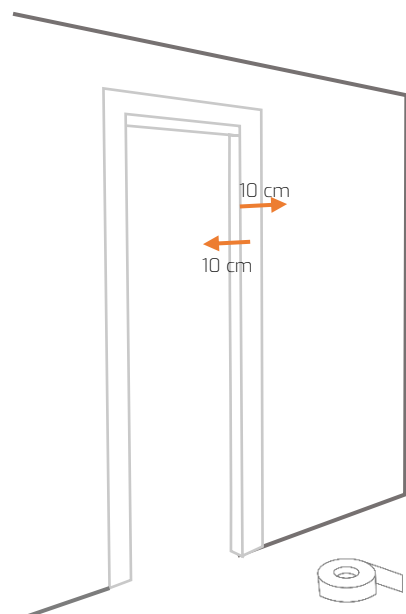
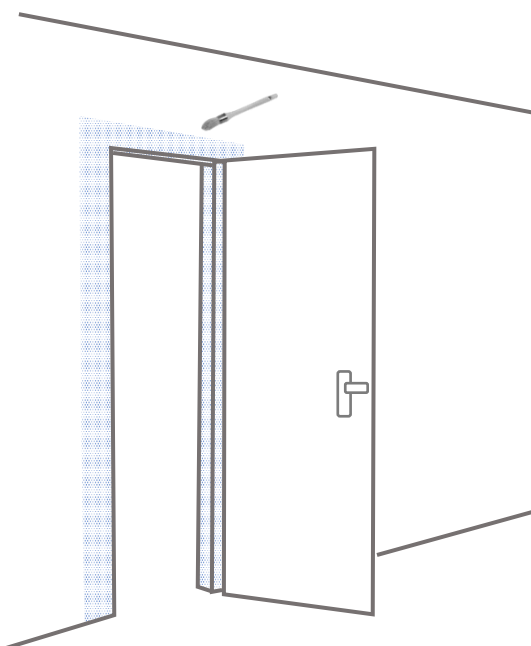

CORSO|SHIELD

Wall

- To apply the Extra 20 cm to **conduits**, use a brush to apply CorsoGlue glue to the entire conduit, avoiding the switches. Then apply the Extra 20 cm evenly: 10 cm on each side of the tube.

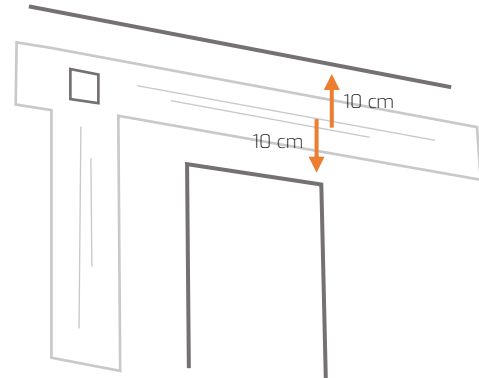
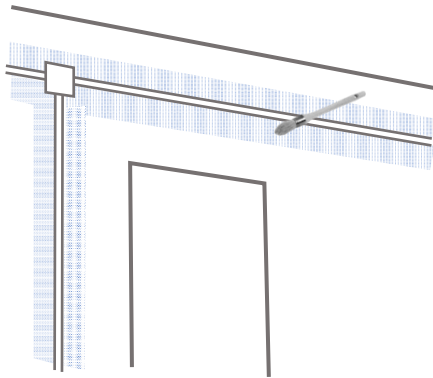

2nd step: Application of the lengths:

- Apply CorsoGlue using a roller over the area, approximately 85 centimeters wide (3 to 5 cm more than the length on each side), use the brush to fill in the corners. / ! \ Do not forget to apply glue to the ceiling, about 3 to 5 centimeters.

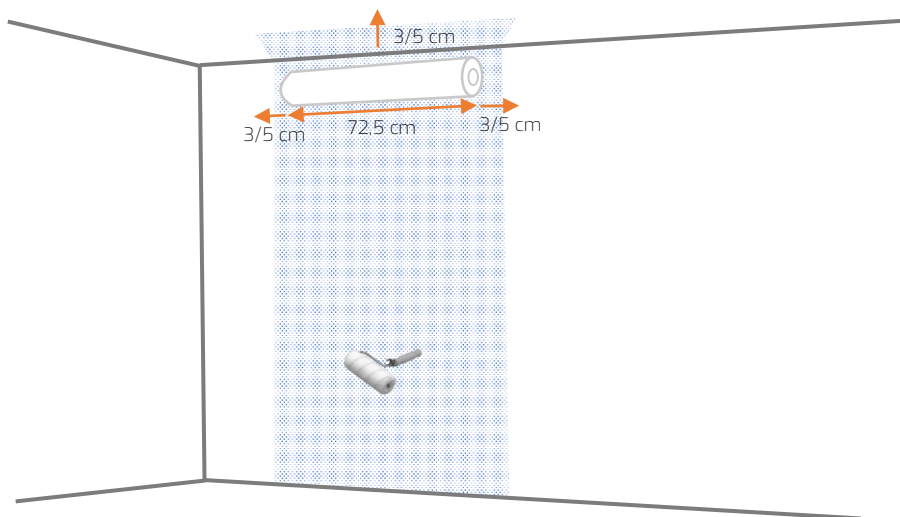

CORSO|SHIELD

Wall

- Unroll the first length, apply from top to bottom, smoothing as you go.

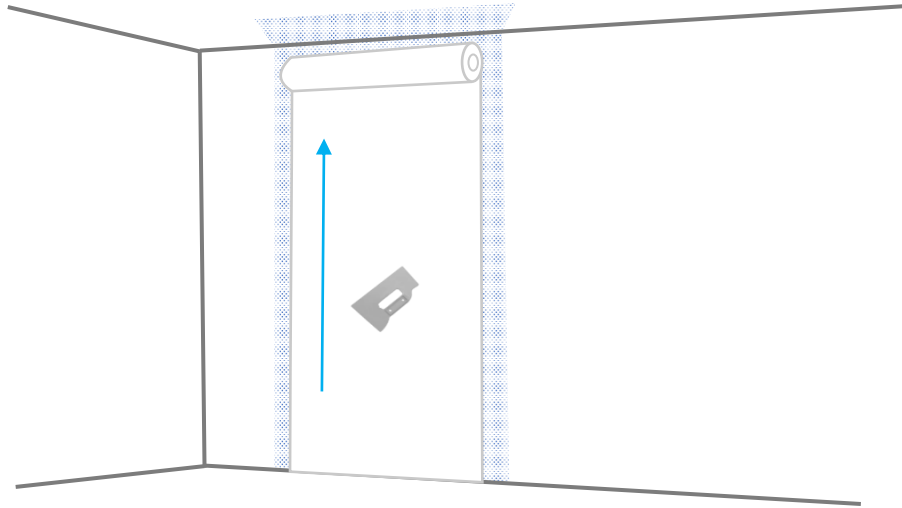

- Apply the next length by superimposing about 3 to 5cm over the first strip.

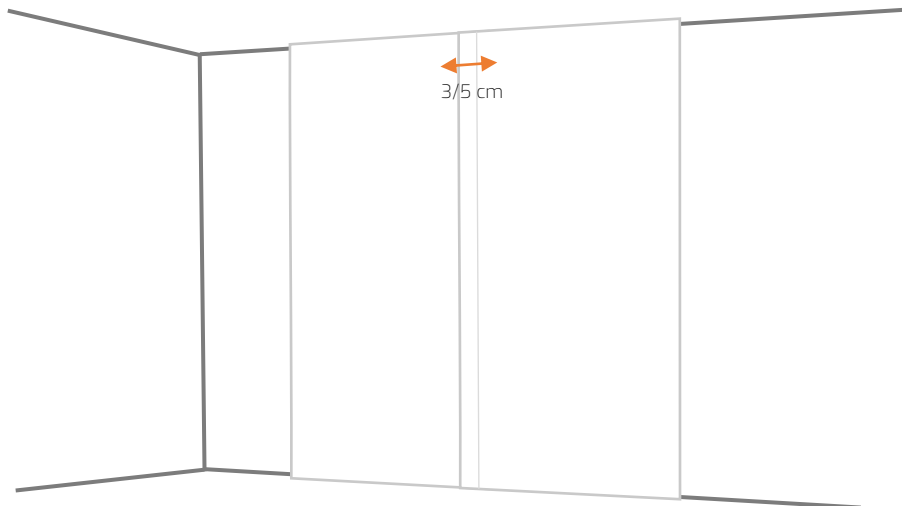

- For the following lengths do the same.

CORSO|SHIELD

Wall

Insertions : Electrical outlets, Switches, Alarms, Ventilation, Signage, Intercom...

- Using a brush and a roller, apply the glue to the entire surface, avoiding the cut-out areas, then apply the length.

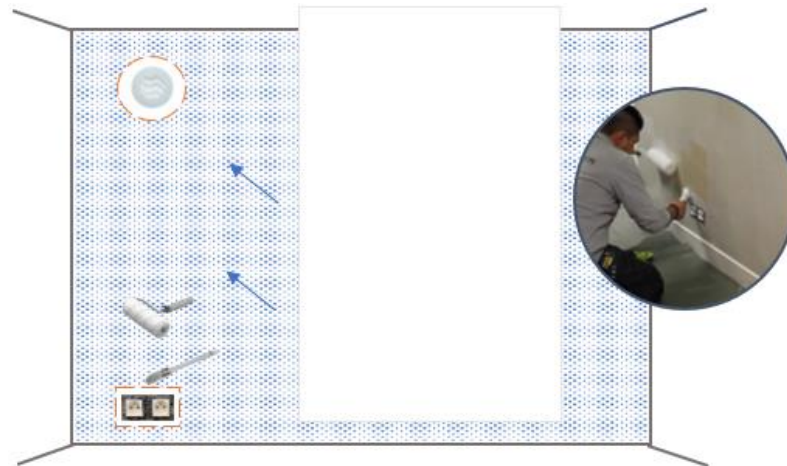

- Using a cutter, cut the strip at the level of the inserts.

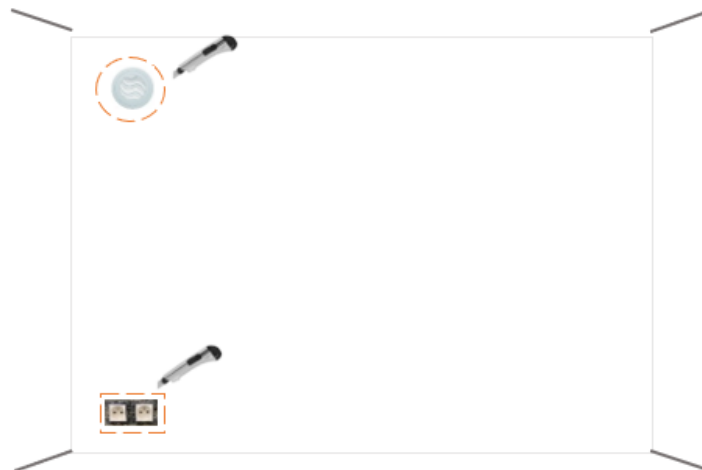

Video application guide:

